

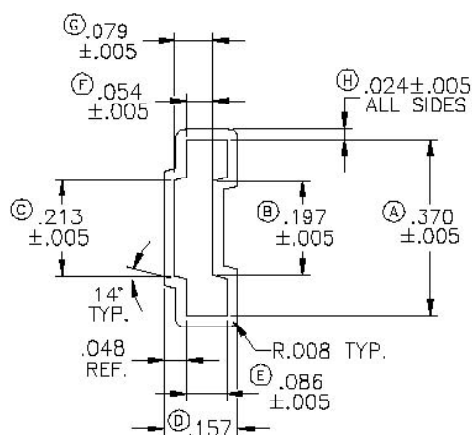

**Future Technology Devices International Ltd.**

# **FT232R / FT245R Device Packing Information.**

FT232RL and FT245RL devices come in a 28 pin SSOP package which is supplied in tube format, as standard (47 devices per tube). The dimensions of the tubes used are shown below -

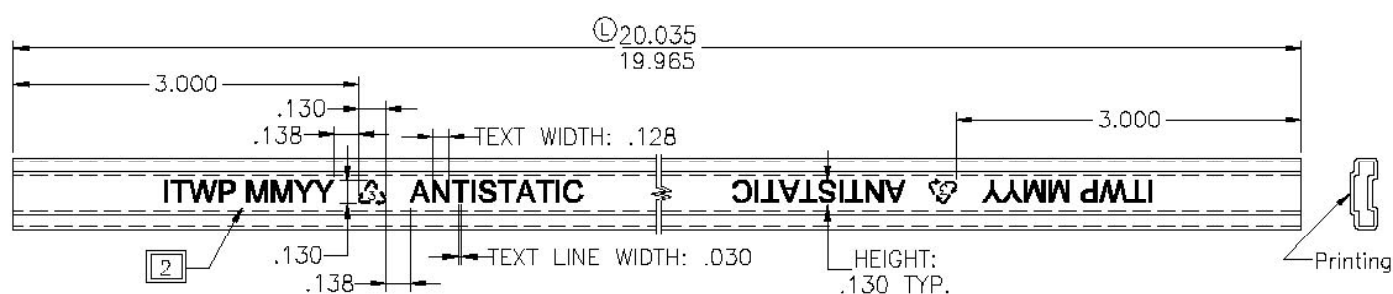

TUBE COLOUR:	CLEAR
PRINT COLOUR:	PANTONE 187C RED

1. ALL DIMENSIONS ARE IN INCHES, U.S.S  
 2. SUPPLIER CODE & DATE CODE[ITWM MMY]:-

MM= Calendar Month  
 YY= Calendar Year

**[DATE CODE CHANGE EVERY MONTH]**

1. ALL TUBE TOLERANCES TO BE  $\pm 0.010$  UNLESS OTHERWISE SPECIFIED.  
 2. ALL RADII AND ANGLES REFERENCE ONLY, UNLESS OTHERWISE SPECIFIED.  
 3. STRAIGHTNESS TIR .030" MAX.

The FT232RQ and FT245RQ devices come in a leadless QFN-32 package which is supplied in tray format as standard (490 devices per tray). The dimensions of the trays used are shown on this page and the next -

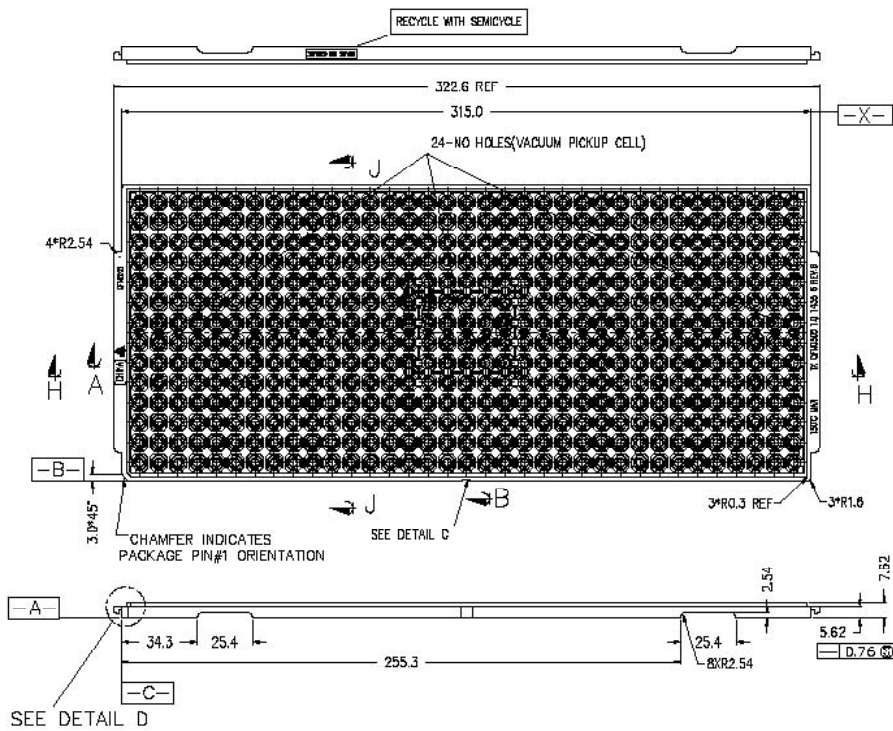

SECTION A-  
( M 5:1 )

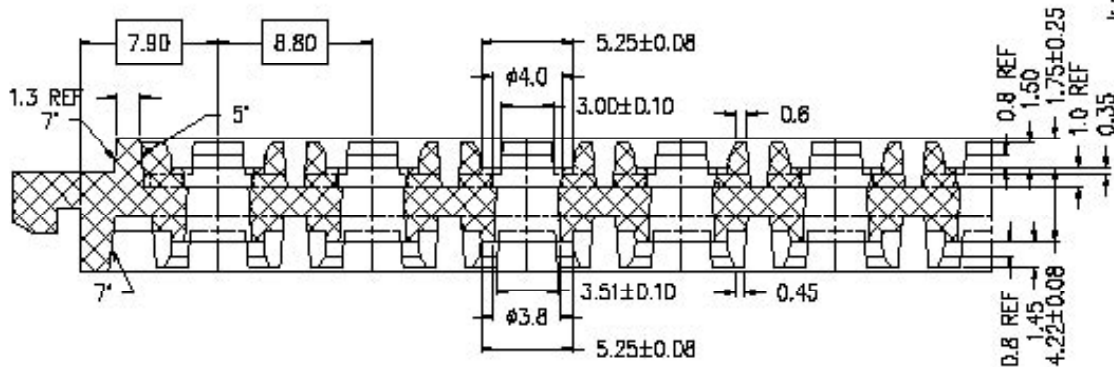

SECTION B-B  
( M 5:1 )

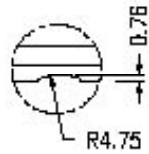
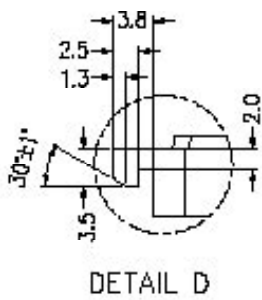
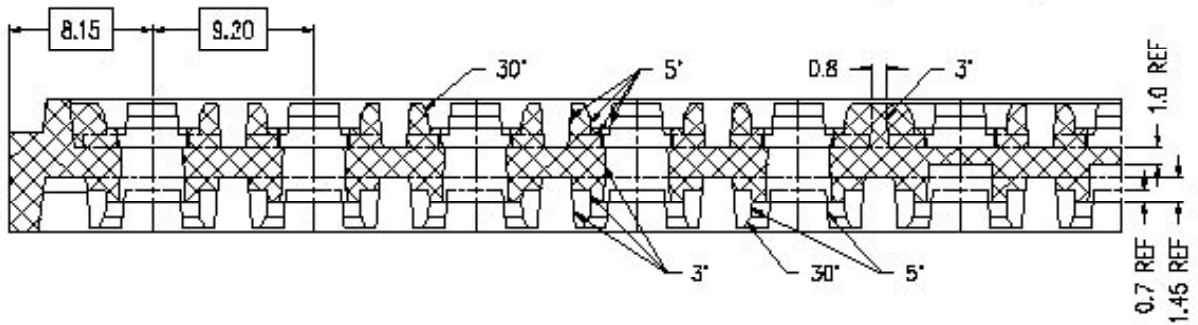

DETAIL C  
NOTE: SCALLOP IS CENTERED  
ON SIDE OF TRAY

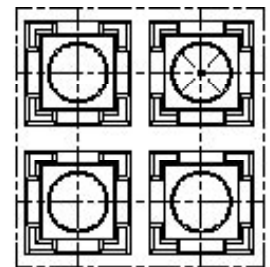

BOTTOM VIEW  
( M 4:1 )

## Disclaimer

---

### Copyright © Future Technology Devices International Limited, 2005.

Version 0.90 - Initial Document Created December 2005

Neither the whole nor any part of the information contained in, or the product described in this manual, may be adapted or reproduced in any material or electronic form without the prior written consent of the copyright holder.

This product and its documentation are supplied on an as-is basis and no warranty as to their suitability for any particular purpose is either made or implied.

Future Technology Devices International Ltd. will not accept any claim for damages howsoever arising as a result of use or failure of this product. Your statutory rights are not affected.

This product or any variant of it is not intended for use in any medical appliance, device or system in which the failure of the product might reasonably be expected to result in personal injury.

This document provides preliminary information that may be subject to change without notice.

### Contact FTDI

#### Head Office -

##### Future Technology Devices International Ltd.

373 Scotland Street,  
Glasgow G5 8QB,  
United Kingdom  
Tel. : +(44) 141 429 2777  
Fax. : +(44) 141 429 2758

E-Mail (Sales) : [sales1@ftdichip.com](mailto:sales1@ftdichip.com)  
E-Mail (Support) : [support1@ftdichip.com](mailto:support1@ftdichip.com)  
E-Mail (General Enquiries) : [admin1@ftdichip.com](mailto:admin1@ftdichip.com)

#### Regional Sales Offices -

##### Future Technology Devices International Ltd. (Taiwan)

4F, No 16-1,  
Sec. 6 Mincyuan East Road,  
Neihu District,  
Taipei 114,  
Taiwan, R.o.C.  
Tel.: +886 2 8791 3570  
Fax: +886 2 8791 3576

E-Mail (Sales): [tw.sales@ftdichip.com](mailto:tw.sales@ftdichip.com)  
E-Mail (Support): [tw.support@ftdichip.com](mailto:tw.support@ftdichip.com)  
E-Mail (General Enquiries): [tw.admin@ftdichip.com](mailto:tw.admin@ftdichip.com)

##### Future Technology Devices International Ltd. (USA)

5285 NE Elam Young  
Parkway, Suite B800  
Hillsboro,  
OR 97124-6499  
USA  
Tel.: +1 (503) 547-0988  
Fax: +1 (503) 547-0987

E-Mail (Sales): [us.sales@ftdichip.com](mailto:us.sales@ftdichip.com)  
E-Mail (Support): [us.support@ftdichip.com](mailto:us.support@ftdichip.com)  
E-Mail (General Enquiries): [us.admin@ftdichip.com](mailto:us.admin@ftdichip.com)

Website URL : <http://www.ftdichip.com>